

# PSX: DIRECT DRIVE

## PIPE TO MANHOLE & TANK CONNECTOR

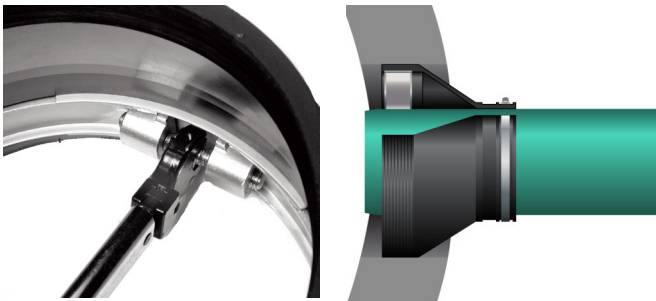
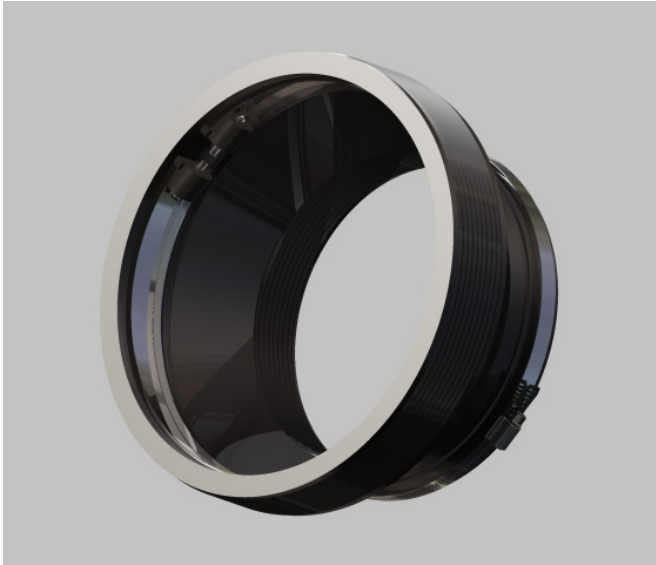

Press-Seal Corporation is the only boot style connector manufacturer that uses multiple mechanisms under 56" as a standard.

Press-Seal recommends installation between a 10:00 and 2:00 position.

### Where To Use

- Manholes
- Wet wells
- Square pump and lift stations
- Stormwater structures
- On-site treatment structures
- Junction chambers
- Grease interceptors
- Vaults

### What It Is

PSX: Direct Drive is a high-performance flexible pipe-to-manhole connector that offers easy installation and long-term performance in one convenient product.

Whether you core or cast your holes, PSX: Direct Drive fits right into your production methods, ready to seal your toughest applications every time.

### How It Works

- The connector fits into a cast or cored hole.
- A power sleeve made from tempered series 304 stainless steel expands with a certified installation wrench.
- Take-up clamps made from series 304 stainless steel with quick adjusting screws secure the connector to the pipe.

### Why It's Better

- Safely install from outside of the manhole preventing falls from crawling down into structures.
- All stainless-steel components with no welds or rivets creating a stronger product.
- Precision molding provides accurate compensation for hole size variations.
- Additional torque and multiple adjusters on larger diameters.
- Contractor can save time and money by backfilling immediately.

All connectors are made with either EPDM or ISOPRENE rubber which meet ASTM C-923. Connectors are available in NITRILE rubber upon request. Contact your territory manager for more information

Press-Seal believes all information is accurate as of its publication date. Information, specifications, and prices are all subject to change without notice. Press-Seal is not responsible for any inadvertent errors. Copyright 2025.

Phone: 800-348-7325  
Fax: (260) 436-1908

**PRESS-SEAL CORPORATION**  
Protecting Our Planet's Clean Water Supply  
ISO 9001: Registered • Version 03.11.25.3.59

Email: sales@press-seal.com  
Web: www.press-seal.com



# Dial Indicator Development

## Why You Should Specify Boot Connector Systems With Multiple Adjusters

During the development of the PSX: Direct Drive, Press-Seal designed a specialized testing instrument that allowed us to gauge the rubber deformation points around the entire boot during installation. The point furthest from the adjuster mechanism, as shown in Figure 1, created the least amount of rubber deformation against the concrete hole. The reduced deformation of rubber at that point indicates that the sealing force of the boot is weakest at the area furthest from the adjuster. This was supported by an external hydrostatic test. When pressurized beyond standard specification levels, the boot would begin to move out of the hole starting at the low deformation point. These tests led to the

adoption of additional adjusters in larger hole sizes to improve the sealing functionality of the Direct Drive boot and equalize sealing force around the entire circumference of the boot.

We are now able to improve the sealing performance on larger sizes of a connector system by adding multiple mechanisms to dramatically reduce the sealing distance from each adjuster. Our adjuster bolt design with both right and left handed nuts allow for less installation friction; therefore, greater torque is applied against the rubber than competitive systems that use a long bolt with multiple wedge style components. In addition, we employ no welds or rivets in our bands or adjuster assemblies. Multiple mechanisms provide for a longer product life.

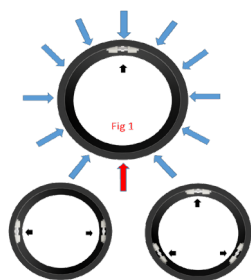
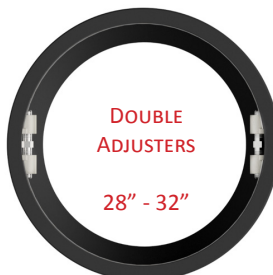

Press-Seal believes all information is accurate as of its publication date. Information, specifications, and prices are all subject to change without notice. Press-Seal is not responsible for any inadvertent errors. Copyright 2025.

Phone: 800-348-7325  
Fax: (260) 436-1908

**PRESS-SEAL CORPORATION**  
*Protecting Our Planet's Clean Water Supply*  
ISO 9001: Registered • Version 03.11.25.3.59

Email: [sales@press-seal.com](mailto:sales@press-seal.com)  
Web: [www.press-seal.com](http://www.press-seal.com)

# PSX: DIRECT DRIVE

## SUBMITTAL SPECIFICATIONS

Pipe-to-Manhole and Structure Connector Specification for Sanitary and Storm Sewer Applications:

All pipe-to-manhole and structure connections shall meet and or exceed ASTM C 923, Standard Specification for Resilient Connectors Between Reinforced Concrete Manholes, Structures, Pipes and laterals.

All mechanical devices, including castings, bolt assemblies, adjusters shall use non-magnetic 300 series stainless steel with no welds or rivets in its assemblies.

Connector sizes less than 28" shall employ one adjuster, 28" - 34" two adjusters and 36" and larger three adjusters.

If thermal plastic internal expansion rings are used, they must be heavy duty automotive grade material molded in one piece with an expansion installation mechanism made of a stainless steel threaded insert (not steel to plastic threads) and embedded as part of the expansion mechanism. Multiple plastic parts as part of the expansion mechanism are not allowed.

The installation of the connector shall be accomplished at one time and shall require no additional adjustments or installation at a later time to insure a watertight seal.

Take up clamps shall use non-magnetic 304 series stainless steel and be installed in the field using a T-Handle Torque wrench set to 60 inch-pounds and installation shall follow manufacturer's instructions.

The connector shall be PSX: Direct Drive and PSX: Nylo Drive as manufactured by Press-Seal Corporation of Fort Wayne, IN or approved equal.

## Product Performance

PSX: Direct Drive, PSX: Nylo Drive, PSX: Wedge Drive meets or exceeds all requirements of the following Specifications and/or Test Methods:

- ASTM C 923 - Standard Specification for Resilient Connectors Between Reinforced Concrete Manhole Structures, Pipes, and Laterals
- ASTM C 1244 Standard Test Method for Concrete Sewer Manholes by the Negative Air Pressure (Vacuum) Test
- ASTM C 1478 - Standard Specification for Storm Drain Resilient Connectors Between Reinforced Concrete ZPipes, and Laterals
- ASTM F 2510 Standard Specification for Resilient Connectors Between Reinforced Concrete Manhole Structures and Corrugated High Density Polyethylene Drainage Pipes

Press-Seal believes all information is accurate as of its publication date. Information, specifications, and prices are all subject to change without notice. Press-Seal is not responsible for any inadvertent errors. Copyright 2025.



# PSX: DIRECT DRIVE

## 8QRS Direct Drive MULTI-SIZE

### What It Is

The 8QRS PSX: Direct Drive provides a simple method for installing small diameter pipes into manholes or other structures.

The unique design of 8QRS allows it to be easily adapted to 1-1/2" to 4" (38 – 100 mm) PVC pipes, either in the plant or in the field.

The reliable tempered series 304 stainless steel power sleeve allows for easy adjustment in almost any 8" cored or cast hole for a watertight connection.

### How It Works

- Sections are cut off to adapt to different PVC pipe sizes.
- The connector fits into a cast or cored hole.
- A power sleeve made from tempered series 304 stainless steel expands with a certified installation wrench.
- Take-up clamps made from series 304 stainless steel with quick adjusting screws secure the connector to the pipe.

### Why It's Better

- Adaptability to a range of PVC pipe sizes all in one connector.
- Safely install the connector from the outside of the manhole.
- All stainless-steel components with no welds or rivets creating a stronger product.
- Precision molding provides accurate compensation for hole size variations.
- Contractor can save time and money by backfilling immediately.

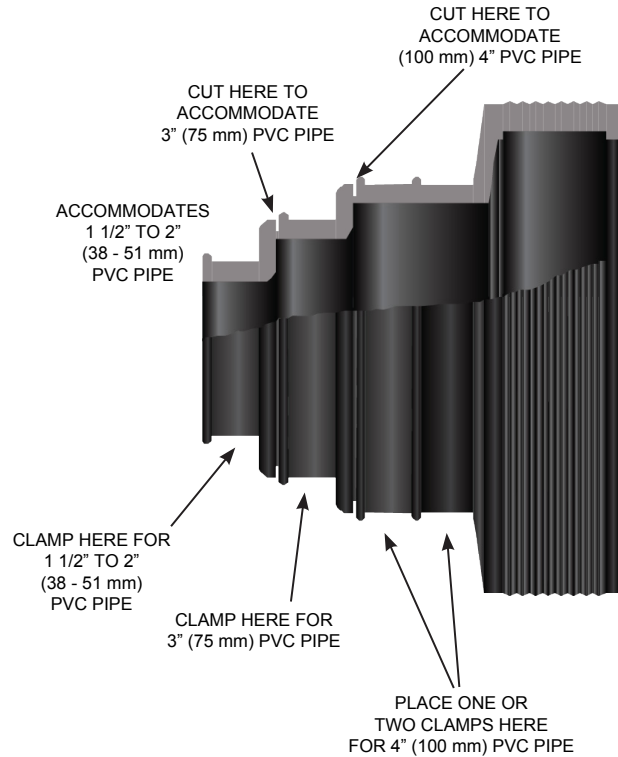

**NITRILE** 

8QRS PSX: Direct Drive is available in Oil-Resistant Nitrile rubber.



Press-Seal believes all information is accurate as of its publication date. Information, specifications, and prices are all subject to change without notice. Press-Seal is not responsible for any inadvertent errors. Copyright 2025.

Phone: 800-348-7325  
Fax: (260) 436-1908

**PRESS-SEAL CORPORATION**  
*Protecting Our Planet's Clean Water Supply*  
ISO 9001: Registered • Version 03.11.25.3.59

Email: [sales@press-seal.com](mailto:sales@press-seal.com)  
Web: [www.press-seal.com](http://www.press-seal.com)

# PSX: DIRECT DRIVE

## SELECTION GUIDE Pipe OD 1.90" - 6.90" (48mm - 175mm)

PIPE DESCRIPTION	PIPE O.D. INCH	HOLE SIZE RANGE INCH	HOLE SIZE RANGE mm	PSX: DD SIZE DESIGNATION
1.5" PVC	1.90" 48 mm	8.00 - 8.20	203- 208 mm	8 QRS "STEP S" PSX
2" PVC	2.38" 60 mm			8 QRS "STEP S" PSX
2" CI/DI	2.50" 64 mm			8 QRS "STEP S" PSX
2.25" CI/DI	2.75" 70 mm			8 QRS "STEP R" PSX
3" PVC	3.50" 89 mm			8 QRS "STEP R" PSX
3" CI/DI	3.96" 101 mm			8 QRS "STEP Q" PSX
4" (100 mm) PVC D3033 OR D3034	4.21" 107 mm			8 QRS "STEP Q" PSX
4" (100 mm) TRUSS	4.30" 109 mm			8 QRS "STEP Q" PSX
4" (100 mm) CI/DI 4" (100 mm) C900 PVC	4.80" 122 mm			8 QRS "STEP Q" PSX
6" (150 mm) PVC D3033 OR D3034	6.275" 159 mm			9.00 - 9.20
		10.00 - 10.20	254 - 259 mm	10-06 PSX: DD
		10.50 - 10.70	267 - 272 mm	10.5-06 PSX: DD
		11.00 - 11.20	279 - 284 mm	11-06 PSX: DD
		12.00 - 12.20	305 - 310 mm	12-06 PSX: DD 12Y PSX: DD
6" (150 mm) TRUSS	6.30" 160 mm	9.00 - 9.20	229 - 234 mm	9-06 PSX: DD
		10.00 - 10.20	254 - 259 mm	10-06 PSX: DD
		10.50 - 10.70	267 - 272 mm	10.5-06 PSX: DD
		11.00 - 11.20	279 - 284 mm	11-06 PSX: DD
		12.00 - 12.20	305 - 310 mm	12-06 PSX: DD 12Y PSX: DD
6" (150 mm) PVC D3033 OR D3034	6.625" 168 mm	10.00 - 10.20	254 - 259 mm	10-06 PSX: DD
		10.50 - 10.70	267 - 272 mm	10.5-06 PSX: DD
		11.00 - 11.20	279 - 284 mm	11-06 PSX: DD
		12.00 - 12.20	305 - 310 mm	12-06 PSX: DD 12Y PSX: DD
6" (150 mm) CI/DI 6" (150 mm) C900 PVC	6.90" 175 mm	10.50 - 10.70	267 - 272 mm	10.5-06 PSX: DD
		11.00 - 11.20	279 - 284 mm	11-06 PSX: DD
		12.00 - 12.20	305 - 310 mm	12-06 PSX: DD 12Y PSX: DD

Press-Seal believes all information is accurate as of its publication date. Information, specifications, and prices are all subject to change without notice. Press-Seal is not responsible for any inadvertent errors. Copyright 2025.



# PSX: DIRECT DRIVE

## SELECTION GUIDE PIPE OD 8.16" - 16.00" (207mm - 406mm)

PIPE DESCRIPTION	PIPE O.D. INCH	HOLE SIZE RANGE INCH	HOLE SIZE RANGE mm	PSX: DD SIZE DESIGNATION
8" (200 mm) PVC D3033	8.16" 207 mm	11.00 - 11.20	279 - 284 mm	11-08 PSX: DD
		12.00 - 12.20	305 - 310 mm	12-08 PSX: DD
				12-08.A PSX: DD
				12M PSX: DD
8" (200 mm) PVC D3034	8.40" 213 mm	11.00 - 11.20	279 - 284 mm	11-08 PSX: DD
		12.00 - 12.20	305 - 310 mm	12-08 PSX: DD
				12-08.A PSX: DD
				12M PSX: DD
8" (200 mm) PVC D2241	8.625" 219 mm	12.00 - 12.20	305 - 310 mm	12-08 PSX: DD
				12-08.A PSX: DD
				12M PSX: DD
8" (200 mm) CI/DI 8" C900 PVC	9.05" 230 mm	12.00 - 12.20	305 - 310 mm	12-08.A PSX: DD
				12M PSX: DD
				12-11 PSX: DD
8" (200 mm) TRUSS	9.40" 239 mm	12.00 - 12.20	305 - 310 mm	12-11 PSX: DD
10" (250 mm) PVC D3033	10.20" 259 mm	13.00 - 13.20	330 - 335 mm	13-10 PSX: DD
		14.00 - 14.20	356 - 361 mm	14M PSX: DD
		16.00 - 16.20	406 - 411 mm	16Y PSX: DD
10" ADS DW SaniTite® w/Nyloplast® PVC Adapter	10.50" 267 mm	13.00 - 13.20	330 - 335 mm	13-10 PSX: DD
		14.00 - 14.20	356 - 361 mm	14M PSX: DD
		16.00 - 16.20	406 - 411 mm	16Y PSX: DD
10" (250 mm) PVC D2241	10.75" 273 mm	14.00 - 14.20	356 - 361 mm	14M PSX: DD
		16.00 - 16.20	406 - 411 mm	16Y PSX: DD
10" (250 mm) CI/DI 10" (250 mm) C900 PVC	11.10" 282 mm	14.00 - 14.20	356 - 361 mm	14M PSX: DD
		16.00 - 16.20	406 - 411 mm	16Y PSX: DD
10" (250 mm) TRUSS	11.80" 300 mm	16.00 - 16.20	406 - 411 mm	16L PSX: DD
12" (300 mm) PVC D3033	12.24" 311 mm			16L PSX: DD
				16M PSX: DD
12" (300 mm) PVC D3034 12" ADS Nyloplast PVC Adapter	12.50" 318 mm			16M PSX: DD
				16M PSX: DD
12" (300 mm) PVC D2241	12.75" 324 mm			16M PSX: DD
12" (300 mm) CI/DI 12" C900 PVC	13.20" 335 mm			16M PSX: DD
12" (250 mm) TRUSS	14.10" 358 mm			18.00 - 18.20
15" (375 mm) PVC D3033 OR D3034 14" (350 mm) CI/DI 15" ADS Nyloplast® PVC Adapter	15.30" 389 mm	18.00 - 18.20	457 - 462 mm	18M PSX-2: DD
		20.00 - 20.20	508 - 513 mm	20Y PSX-2: DD
12" (300 mm) RCP WALL B	16.00" 406 mm	20.00 - 20.20	508 - 513 mm	20Y PSX-2: DD OR 20A PSX-2: DD

Press-Seal believes all information is accurate as of its publication date. Information, specifications, and prices are all subject to change without notice. Press-Seal is not responsible for any inadvertent errors. Copyright 2025.



Phone: 800-348-7325  
Fax: (260) 436-1908

**PRESS-SEAL CORPORATION**  
Protecting Our Planet's Clean Water Supply  
ISO 9001: Registered • Version 03.11.25.3.59

Email: sales@press-seal.com  
Web: www.press-seal.com

# PSX: DIRECT DRIVE

## SELECTION GUIDE Pipe OD 14.10" - 44.0" (358mm - 1118mm)

PIPE DESCRIPTION	PIPE O.D. INCH	HOLE SIZE RANGE INCH	HOLE SIZE RANGE mm	PSX:DD SIZE DESIGNATION
16" (400 mm) CI/DI	17.40" 442 mm	20.00 - 20.20	508 - 513 mm	20A PSX-2: DD
		22.00 - 22.20	559 - 564 mm	22L PSX-2: DD
15" (375 mm) TRUSS	17.70" 450 mm	22.00 - 22.20	559 - 564 mm	22L PSX-2: DD
18" (450 mm) PVC F679 18" ADS Nyloplast® PVC Adapter	18.70" 475 mm	22.00 - 22.20	559 - 564 mm	22M PSX-2: DD
18" (450 mm) CI/DI 15" (375 mm) RCP WALL B	19.50" 495 mm	24.00 - 24.20	610 - 615 mm	24L PSX-2: DD
20" (500 mm) CI/DI	21.60" 549 mm	26.00 - 26.20	660 - 665 mm	26L PSX-2: DD
21" (500 mm) PVC F679 21" ADS Nyloplast® PVC Adapter	22.04" 560 mm	26.00 - 26.20	660 - 665 mm	26L PSX-2: DD
18" (450 mm) RCP WALL B	23.00" 584 mm	26.00 - 26.20	660 - 665 mm	26A PSX-2: DD
24" (600 mm) PVC 24" ADS Nyloplast® PVC Adapter	24.80" 630 mm	28.00 - 28.20	711 - 716 mm	28A PSX-2:DD
24" (600 mm) CI/DI	25.80" 655 mm	30.00 - 30.20	762 - 767 mm	30L PSX-2: DD
21" (500 mm) RCP WALL B	26.50" 673 mm	30.00 - 30.20	762 - 767 mm	30A PSX-2: DD
27" (675 mm) PVC F679	27.95" 710 mm	32.00 - 32.20	813 - 818 mm	32L PSX-2: DD
24" (600 mm) RCP WALL B	30.00" 762 mm	34.00 - 34.20	864 - 869 mm	34L PSX-2: DD
24" (600 mm) CONCRETE WALL C	31.50" 800 mm	36.00 - 36.20	914 - 919 mm	36A PSX-2: DD
30" (750 mm) DI/CI OR 30" (740 mm) PVC	32.00" 813 mm	36.00 - 36.20	914 - 919 mm	36A PSX-2: DD
27" (675 mm) CONCRETE WALL B	33.50" 851 mm	38.00 - 38.20	965 - 967 mm	38A PSX-2: DD
27" (675 mm) CONCRETE WALL C	35.00" 889 mm	40.00 - 40.20	1016 - 1020 mm	40L PSX-2: DD
30" SaniTite® HP TW	35.30" 896 mm	40.00 - 40.20	1016 - 1020 mm	40L PSX-2: DD
30" (750 mm) CONCRETE WALL B	37.00" 940 mm	42.00 - 42.20	1067 - 1072 mm	42L PSX-2: DD
30" (750 mm) CONCRETE WALL C	38.50" 977 mm	42.00 - 42.20	1067 - 1072 mm	42A PSX-2: DD
36" (900 mm) DI/CI	38.30" 973 mm	42.00 - 42.20	1067 - 1072 mm	42A PSX-2: DD
36" SaniTite® HP TW	41.20" 1046 mm	46.00 - 46.20	1016 - 1020 mm	46L PSX-2: DD
36" (900 mm) CONCRETE WALL B	44.00" 1118 mm	48.00 - 48.20	1219 - 1224 mm	48L PSX-2: DD

Press-Seal believes all information is accurate as of its publication date. Information, specifications, and prices are all subject to change without notice. Press-Seal is not responsible for any inadvertent errors. Copyright 2025.



# PSX: DIRECT DRIVE CONNECTOR CROSS REFERENCE

PSX: DD SIZE DESCRIPTION	HOLE SIZE RANGE		PIPE O.D. ACCOMMODATION RANGE INCHES (mm)		GASKET I.D.		TAKE-UP CLAMP		NUMBER OF EXPANSION SLEEVE MECHANISMS	MINIMUM SIZE ROUND STRUCTURE (INCHES)
	INCH	mm	INCHES (mm)	INCH	mm	QTY	PART #			
REQUIRES BLACK SHORT 7/16 TORQUE WRENCH PRESET TO 12 FT/LBS PART # 850.605										
8 QRS STEP "S" PSX: DD 8 QRS STEP "R" PSX: DD 8 QRS STEP "Q" PSX: DD 8 QRS PSX: DD 8-11 PSX: DD	8.00 - 8.20	203 - 206	1.70" TO 2.50" 2.75" TO 3.75" 3.75" TO 4.80" 1.90" TO 4.80" 4.80" TO 5.65"	43 - 64 mm 70 - 95 mm 95 - 122 mm 48 - 122 mm 122 - 144 mm	2.20 3.50 4.60 N/A 5.64	56 mm 89 mm 117 mm N/A 143 mm	1 1 1 1 1	600.088 600.088 600.088 600.088 600.128	1	24
09-06 PSX: DD	9.00 - 9.20	229 - 234	6.00" TO 6.50"	152 - 165 mm	6.45	164 mm	1	600.128	1	24
10-06 PSX: DD 10-11 PSX: DD	10.00 - 10.20	254 - 259	5.50" TO 6.90" 6.60" TO 7.50"	140 - 175 mm 168 - 191 mm	6.50 7.33	165 mm 186 mm	1 1	600.128 600.152	1	24
10.5-06 PSX: DD	10.50 - 10.70	267 - 272	5.70" TO 6.90"	145 - 175 mm	6.30	160 mm	1	600.128	1	24
11-06 PSX: DD 11-08 PSX: DD	11.00 - 11.20	279 - 284	5.70" TO 6.90" 8.00" TO 8.50"	145 - 175 mm 203 - 220 mm	6.30 8.44	160 mm 214 mm	1 1	600.128 600.152	1	24
12-06 PSX: DD 12Y PSX: DD 12-08 PSX: DD 12-08.A PSX: DD 12M PSX: DD 12-11 PSX: DD	12.00 - 12.20	305 - 310	5.70" TO 6.90" 5.70" TO 6.90" 8.00" TO 8.65" 8.00" TO 9.10" 8.00" TO 9.10" 8.60" TO 9.50"	145 - 175 mm 145 - 175 mm 203 - 219 mm 203 - 231 mm 203 - 231 mm 218 - 241 mm	6.30 6.30 8.44 8.65 8.63 9.46	160 mm 160 mm 165 mm 214 mm 219 mm 240 mm	1 1 1 1 1 1	600.128 600.128 600.152 600.152 600.152 600.188	1	24
13-10 PSX: DD	13.00 - 13.20	330 - 335	9.75" TO 10.50"	248 - 267 mm	10.65	271 mm	1	600.188	1	24
14M PSX: DD 14A PSX: DD	14.00 - 14.20	356 - 361	9.75" TO 11.10" 10.75" TO 11.30"	248 - 282 mm 273 - 287 mm	10.35 11.10	263 mm 475 mm	1 1	600.188 600.232	1	30
REQUIRES BLUE 1/2 TORQUE WRENCH PRESET TO 20 FT/LBS PART # 850.610										
16Y PSX: DD 16L PSX: DD 16M PSX: DD	16.00 - 16.20	406 - 411	10.00" TO 11.10" 11.36" TO 12.50" 12.05" TO 13.30"	254 - 282 mm 289 - 318 mm 306 - 338 mm	10.75 12.10 12.75	273 mm 307 mm 324 mm	1 1 1	600.188 600.232 600.232	1	36
18Y PSX-2: DD 18M PSX-2: DD	18.00 - 18.20	457 - 462	13.20" TO 14.50" 14.60" TO 15.50"	335 - 368 mm 371 - 394 mm	14.10 15.35	356 mm 390 mm	2 2	600.296 600.296	1	36
20Y PSX: DD 20A PSX: DD	20.00 - 20.20	508 - 513	14.80" TO 16.00" 16.00" TO 17.40"	376 - 406 mm 406 - 442 mm	15.50 16.92	394 mm 430 mm	2 2	600.296 600.296	1	36
REQUIRES RED 5/8 TORQUE WRENCH PRESET TO 60 FT/LBS PART # 850.632										
22L PSX-2: DD 22M PSX-2: DD	22.00 - 22.20	559 - 564	17.00" TO 18.15" 18.00" TO 19.20"	432 - 461 mm 457 - 488 mm	17.80 18.70	452 mm 475 mm	2 2	600.376 600.376	1	42
24L PSX-2: DD 24S1 PSX-2: DD 24S PSX-2: DD 24A PSX-2: DD	24.00 - 24.20	610 - 615	19.00" TO 19.75" 19.50" TO 20.25" 20.50" TO 21.50" 21.00" TO 21.50"	483 - 502 mm 495 - 514 mm 521 - 546 mm 533 - 546 mm	19.55 19.85 21.05 21.93	497 mm 504 mm 535 mm 557 mm	2 2 2 2	600.376 600.376 600.376 600.376	1	48
26L PSX-2: DD 26A PSX-2: DD	26.00 - 26.20	660 - 665	21.30" TO 22.40" 22.25" TO 23.25"	541 - 569 mm 565 - 591 mm	22.18 23.12	563 mm 587 mm	2 2	600.376 600.456	1	48
28L PSX-2: DD 28A PSX-2: DD	28.00 - 28.20	711 - 716	23.40" TO 24.60" 24.25" TO 24.80"	594 - 625 mm 616 - 630 mm	24.31 24.80	617 mm 630 mm	2 2	600.456 600.456	2	48
30L PSX-2: DD 30A PSX-2: DD	30.00 - 30.20	762 - 767	25.40" TO 26.60" 26.25" TO 27.40"	645 - 676 mm 667 - 696 mm	26.32 27.12	669 mm 689 mm	2 2	600.456 600.456	2	60
32L PSX-2: DD 32A PSX-2: DD	32.00 - 32.20	813 - 818	27.40" TO 28.60" 28.25" TO 29.40"	696 - 726 mm 718 - 747 mm	28.32 29.13	719 mm 740 mm	4 4	600.296 600.296	2	60
34L PSX-2: DD	34.00 - 34.20	864 - 869	29.50" TO 30.50"	749 - 775 mm	30.33	770 mm	4	600.296	3	60
36L PSX-2: DD 36A PSX-2: DD	36.00 - 36.20	914 - 919	31.00" TO 31.50" 31.50" TO 32.15"	787 - 800 mm 800 - 813 mm	31.33 32.08	796 mm 815 mm	4 4	600.296 600.296	3	72
38A PSX-2: DD 38S PSX-2: DD	38.00 - 38.20	965 - 970	32.70" TO 33.80" 33.75" TO 34.50"	831 - 859 mm 857 - 876 mm	33.59 34.10	853 mm 866 mm	4 4	600.296 600.296	3	72
40L PSX-2: DD 40S PSX-2: DD	40.00 - 40.20	1016 - 1021	34.25" TO 35.50" 35.50" TO 36.00"	870 - 902 mm 902 - 914 mm	35.13 36.00	893 mm 914 mm	4 4	600.376 600.376	3	72
42L PSX-2: DD 42A PSX-2: DD	42.00 - 42.20	1067 - 1072	37.00" TO 38.00" 38.00" TO 38.75"	940 - 965 mm 965 - 984 mm	37.60 38.35	955 mm 974 mm	4 4	600.376 600.376	3	72
46L PSX-2: DD 46S PSX-2: DD	46.00 - 46.20	1168 - 1173	41.00" TO 41.75" 41.50" TO 42.00"	1041 - 1060 mm 1054 - 1067 mm	41.36 42.00	1051 mm 1067 mm	4 4	600.376 600.376	3	84
48L PSX-2: DD	48.00 - 48.20	1219 - 1224	43.60" TO 44.50"	1107 - 1130 mm	44.35	1126 mm	4	600.376	3	84



Press-Seal believes all information is accurate as of its publication date. Information, specifications, and prices are all subject to change without notice. Press-Seal is not responsible for any inadvertent errors. Copyright 2025.

Phone: 800-348-7325  
Fax: (260) 436-1908

**PRESS-SEAL CORPORATION**  
Protecting Our Planet's Clean Water Supply  
ISO 9001: Registered • Version 03.11.25.3.59

Email: sales@press-seal.com  
Web: www.press-seal.com



# PSX: DIRECT DRIVE

## SELECTION GUIDE: ADS N12®, SANITITE® HP & TW

ADS N12® Corrugated Pipe Adapter Gasket			
Drawing numbers for reference: STD-204E, 205C, 207E			
PIPE DESCRIPTION	PIPE O.D.	ADAPTER PART NUMBER	PSX: DIRECT DRIVE
8" 200 mm	9.1" 231 mm	CONTACT ADS	PSX: DD 12-11
10" 250 mm	11.4" 290 mm	CONTACT ADS	PSX: DD 16L
12" 300 mm	14.5" 368 mm	454.1770.12	PSX: DD 18Y
15" 375 mm	17.6" 447 mm	454.1794.15	PSX: DD 22L
18" 450 mm	21.2" 538 mm	454.1776.18	PSX: DD 24S
21" 525 mm	25.1" 638 mm	454.1804.21	PSX: DD 28A
24" 600 mm	27.8" 706 mm	454.1804.24	PSX: DD 32L
30" 750 mm	35.1" 892 mm	454.1802.30	PSX: DD 40L
36" 900 mm	41.1" 1044 mm	CONTACT ADS	PSX: DD 46L
42" 1050 mm	47.3" 1212 mm	CONTACT ADS	STANDARD PSX AVAILABLE
48" 1200 mm	53.8" 1367 mm	CONTACT ADS	N/A
54" 1350 mm	61.0" 1549 mm	N/A	N/A
60" 1524 mm	66.3" 1500 mm	N/A	N/A

**NOTE:** All corrugated style pipe must use an adapter to fill the valleys to be smooth and level with the top of the corrugations.

ADS SaniTite® HP Manhole Sleeve Adapter			
Drawing numbers for reference: STD-205A, 205D, 207A, 207C			
PIPE DESCRIPTION	PIPE O.D.	ADS Adapter Product Code	PSX: DIRECT DRIVE
12" 300mm	15.3" 388.6 mm	1222AAPP	PSX: DD 18Y or 20Y
15" 375 mm	18.3" 464.8 mm	1522AAPP	PSX: DD 22M
18" 450 mm	22.0" 558.8 mm	1822AAPP	PSX: DD 26L
24" 600 mm	29.0" 736.6 mm	2422AAPP	PSX: DD 32A

**NOTE:** The ADS sleeve adapter is exclusively manufactured by and for ADS.

ADS Nyloplast® PVC Pipe Manhole Adapter			
Drawing numbers for reference: STD-205A, 205D, 207A, 207C			
PIPE DESCRIPTION	PIPE O.D.	Nyloplast PVC Product Code	PSX: DIRECT DRIVE
12" 300 mm	12.5" 317.5mm	1257AGHPU2	PSX: DD 16M
15" 375 mm	15.3" 388.6mm	1557AGHPU2	PSX: DD 18M or 20Y
18" 450 mm	18.7" 475.0mm	1857AGHPU2	PSX: DD 22M
21" 525 mm	22.1" 561.3mm	2157AGHPU2	PSX: DD 26L
24" 600 mm	24.8" 629.9mm	2457AGHPU2	PSX: DD 28A

**NOTE:** Nyloplast pipe OD's match standard SDR-35 PVC Pipes

ADS SaniTite® HP TW		
Drawing numbers for reference: STD-205E		
PIPE DESCRIPTION	PIPE O.D.	PSX: DIRECT DRIVE
30" 762 mm	35.3" 897 mm	PSX: DD 40L
36" 914 mm	41.2" 1044 mm	PSX: DD 46L
42" 1066 mm	47.3" 1201 mm	N/A
48" 1219 mm	53.8" 1367 mm	N/A
60" 1524 mm	66.7" 1694 mm	N/A



Press-Seal believes all information is accurate as of its publication date. Information, specifications, and prices are all subject to change without notice. Press-Seal is not responsible for any inadvertent errors. Copyright 2025.



# PSX: DIRECT DRIVE

## SELECTION GUIDE: PRINSCO & HARCO

### Corrugated Pipe Adapter Gasket

Prinsco Goldflo WT®, Goldpro Storm™				Harco PVC Pipe Manhole Adapter			
Drawing numbers for reference: D-1-120, D-2-120				PIPE DESCRIPTION	PIPE O.D.	HARCO PART NUMBER	PSX: DIRECT DRIVE
PIPE DESCRIPTION	PIPE O.D.	ADAPTER PART NUMBER	PSX: DIRECT DRIVE	4" 101.6 mm	4.21" 107 mm	53-3304xx	N/A
6" 152.4 mm	7.1" 180 mm	CONTACT PRINSCO	PSX: DD 10-11	6" 152.4 mm	6.62" 168 mm	53-3306xx	N/A
8" 203.2 mm	9.5" 241 mm	CONTACT PRINSCO	PSX: DD 12-11	8" 203.2 mm	8.40" 207 mm	53-3308xx	PSX: DD 12-11
10" 254 mm	11.9" 302 mm	CONTACT PRINSCO	PSX: DD 16L	10" 254 mm	10.50" 259 mm	53-3310xx	PSX: DD 16L
12" 300 mm	14.3" 363 mm	CONTACT PRINSCO	PSX-2 DD: 18Y	12" 300 mm	12.5" 317.5mm	53-3312xx	PSX-2 DD: 18Y
15" 375 mm	17.5" 445 mm	CONTACT PRINSCO	PSX-2 DD: 22L	15" 375 mm	15.3" 388.6mm	53-3315xx	PSX-2 DD: 22L
18" 450mm	21.6" 549 mm	CONTACT PRINSCO	PSX-2 DD: 24S	18" 450mm	18.7" 475.0mm	53-3318xx	PSX-2 DD: 24S
24" 600 mm	28.4" 629.9 mm	CONTACT PRINSCO	PSX-2 DD: 32L	24" 600 mm	24.8" 629.9mm	53-3324xx	PSX-2 DD: 32L
30" 762 mm	35" 889 mm	CONTACT PRINSCO	PSX-2 DD: 40L	30" 762 mm	32" 813 mm	53-3330xx	PSX-2 DD: 40L
36" 900 mm	41" 1041 mm	CONTACT PRINSCO	PSX-2 DD: 46L	All adaptor corrugated HDPE openings connect to full profile corrugation pipe, pipe gasket provided in most cases.			
42" 1050 mm	47.5" 1207 mm	CONTACT PRINSCO	STANDARD PSX AVAILABLE	<b>NOTE:</b> Nyloplast pipe OD's match standard SDR-35 PVC Pipes			
48" 1200 mm	54.02" 1372 mm	N/A	N/A	HARCO fittings are available for all HDPE manufacturer's. Please contact for availability and pricing.			
<b>NOTE:</b> All corrugated style pipe must use an adapter to fill the valleys to be smooth and level with the top of the corrugations.							

**ORDERING DISCLAIMER:** Adapters and fittings are supplied by pipe manufacturers to provide a smooth and level surface on the outside diameter of the pipe so that boot-style connectors can be used. These adapters and/or fittings may differ from the sizes and types listed above. It is the sole responsibility of the customer to verify the correct OD of the fitting and/or adapter which will be used.

**SPECIAL NOTE:** Installation of large diameter pipe, with or without adapters, requires special care. Consult pipe manufacturer for special installation instructions for each pipe.

Other products available for corrugated pipe are PSX: Nylo Drive, Cast-A-Seal 802 for straight walls, Cast-A-Seal 603, Econoseal and Kwik Seal

For sizes too large for PSX: Direct Drive an alternative is Cast-A-Seal 802. (*Straight wall structures only*)



Phone: 800-348-7325  
Fax: (260) 436-1908

**PRESS-SEAL CORPORATION**  
Protecting Our Planet's Clean Water Supply  
ISO 9001: Registered • Version 03.11.25.3.59

Email: sales@press-seal.com  
Web: www.press-seal.com

# PSX: DIRECT DRIVE

## SELECTION GUIDE: Contech A-2000™ & Prime Conduit Vylon® Pipe

### Profile PVC Pipe

Contech A-2000™ w/Rubber Adapter		
PIPE DESCRIPTION	PIPE O.D.	PSX: DIRECT DRIVE
4" 100 mm	4.30" 109 mm	8 QRS PSX: DD
6" 150 mm	6.42" 150 mm	9-06 PSX: DD 10.5-06 PSX: DD 11-06 PSX: DD 12-06 PSX: DD
8" 200 mm	8.60" 218 mm	12-08 PSX: DD 12M PSX: DD
10" 250 mm	10.79" 274 mm	14M PSX: DD 16Y PSX: DD
12" 300 mm	12.80" 325 mm	16M PSX: DD
15" 375 mm	15.66" 398 mm	20Y PSX-2: DD
18" 450 mm	19.15" 486 mm	24L PSX-2: DD
21" 525 mm	22.59" 574 mm	26A PSX-2: DD
24" 600 mm	25.58" 650 mm	30L PSX-2: DD
30" 750 mm	32.15" 817 mm	36A PSX-2: DD
36" 900 mm	38.74" 984 mm	42A PSX-2: DD

**NOTE:** All corrugated style pipe must use an adapter to fill the valleys to be smooth and level with the top of the corrugations.

Prime Conduit Vylon® Pipe			
PIPE DESCRIPTION	PIPE O.D.		PSX: DIRECT DRIVE
STIFFNES RATING	46 PSI	60/72 PSI	
21" 550 mm	22.11" 562 mm	22.28" 566 mm	26L PSX-2: DD
24" 600 mm	25.04" 638 mm	25.24" 641 mm	Standard PSX Available
27" 700 mm	28.23" 717 mm	28.46" 723 mm	32L PSX-2: DD
30" 750 mm	31.43" 798 mm	31.69" 805 mm	36L PSX-2: DD 36 A PSX-2: DD
36" 900 mm	37.80" 960 mm	38.13" 969 mm	42L PSX-2: DD
42" 1050 mm	44.20" 1123 mm	44.58" 1132 mm	48L PSX-2: DD Standard PSX Available
48" 1200 mm	50.57" 1284 mm	51.02" 1296 mm	Standard PSX Available
54" 1350 mm	56.96" 1447 mm	57.47" 1460 mm	N/A

**NOTE:** Pipe seams should be flat and smooth for all connectors. Consult customer service or territory manager for further instructions.

### P. W. EAGLE/UPONOR ULTRARIB, ULTRACORR W/ PVC ADAPTER

NOTE: Ultrarib and Ultracorr pipe require a smooth PVC adapter for use with PSX:Direct Drive Connectors. Contact Customer Service for more information.

**SPECIAL NOTE:** Installation of large diameter pipe, with or without adapters, requires special care. Consult pipe manufacturer for special installation instructions for each pipe.

For sizes too large for PSX: Direct Drive an alternative is Cast-A-Seal 802. (*Straight wall structures only*)

Press-Seal believes all information is accurate as of its publication date. Information, specifications, and prices are all subject to change without notice. Press-Seal is not responsible for any inadvertent errors. Copyright 2025.



# PSX: DIRECT DRIVE INSTALLATION INSTRUCTIONS

1. Prepare the hole to receive the gasket.
  - a. Clean the hole of any debris or loose dirt.
  - b. Examine the hole for any imperfections (bug holes) and wire ends in the gasket bearing surface.
  - c. Patch any voids (bug holes) with patch compound.
  - d. Remove any wire protruding up into the hole and patch with slurry if needed.
2. Select the correct PSX: Direct Drive wrench. The wrenches and the adjusters are sized so that only the correct wrench can be used with each size adjuster, and will provide the correct torque. **DO NOT USE ANY OTHER SIZE OR TYPE OF WRENCH TO INSTALL PSX: DIRECT DRIVE.**
3. Place the PSX: Direct Drive Connector in the hole with the adjuster mechanism in position so that it will be at the top of the hole (10 to 12 o'clock) in the final installed position of the manhole. Align the Connector so that it is square to the hole.
4. Place the wrench on the adjuster nut so that the arm of the wrench is on the installer's left side. This will ensure that the proper orientation is maintained.
5. Begin to tighten the PSX:Direct Drive Connector by pulling the wrench handle toward the outside of the manhole. The wrench will ratchet back easily at the end of the stroke. If the Connector has multiple adjusters (28" (711 mm) and higher), tighten each adjuster five times, alternating them in sequence so that installation pressure is evenly distributed.
6. Continue tightening until proper torque is reached. The wrench will signal this by "breaking" slightly. If in doubt torque has been reached, tighten again and wrench should "break" quickly and easily. If there are multiple adjusters, make sure that the wrench "breaks" at each one. Installation is now complete.

## ITEMS NEEDED

T-HANDLE TORQUE WRENCH

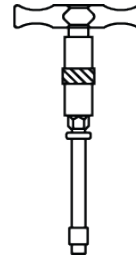

CLAMP



BOOT

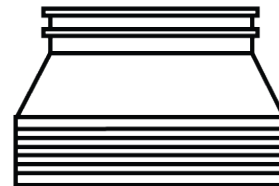

HEX WRENCH



**TIP:** To remove an installed PSX: Direct Drive Connector, simply reverse wrench position and loosen Connector.



Press-Seal believes all information is accurate as of its publication date. Information, specifications, and prices are all subject to change without notice. Press-Seal is not responsible for any inadvertent errors. Copyright 2025.

Phone: 800-348-7325  
Fax: (260) 436-1908

**PRESS-SEAL CORPORATION**  
Protecting Our Planet's Clean Water Supply  
ISO 9001: Registered • Version 03.11.25.3.59

Email: [sales@press-seal.com](mailto:sales@press-seal.com)  
Web: [www.press-seal.com](http://www.press-seal.com)

# PSX: DIRECT DRIVE CLAMPING INSTRUCTIONS: LARGE DIAMETER PIPE

## ITEMS NEEDED

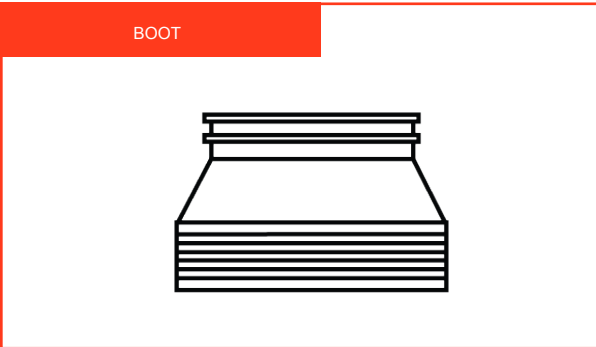
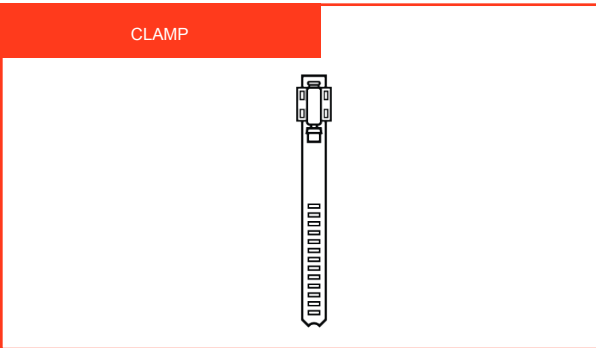
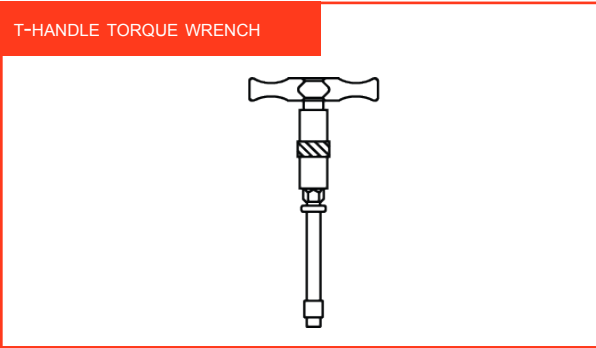

- BOOT INSTALLATION:**
1. Install boot in manhole per Press-Seal Corporation instructions, paying special attention to square alignment of boot in manhole opening.
- PIPE INSTALLATION:**
1. Clean pipe section thoroughly for at least three feet from insertion end. Check and clean boot to ensure no dirt or foreign materials are present.
  2. Center pipe in opening and insert until pipe breaks the inside plane of manhole. Recheck pipe and boot to make sure that they remain clean.
  3. When installing two clamps, start with the groove closest to the hole first. Attach take-up clamps and stagger screws of clamps around the groove of PSX connector so that take-up pressure will be equalized. Usually, it is easiest to tighten the screws if the clamps are placed with the lower screw facing up, as shown below. Make sure that each clamp is completely in the correct groove.
  4. Using a torque ratchet or torque wrench, gradually tighten both screws of **outside** clamp in an alternating pattern to 60 lbs/inch torque. Then tighten both screws on **inside** clamp.
  5. After reaching 60 lbs/inch torque on final screw, check all screws again to ensure equal compression of both clamps.
  6. If system is to be tested, testing should be completed prior to backfilling, following all recommendations and requirements of the test system manufacturer.
  7. Adjust pipe to line and grade. Use proper bedding and backfill materials and techniques so that pipe deflection and deformation is minimized.
  8. Any pipe stubs installed in the manhole must be positively restrained from movement.

**CAUTION:** DO NOT OVERTIGHTEN. A SCREWDRIVER WILL NOT TIGHTEN CLAMPS ADEQUATELY

Press-Seal believes all information is accurate as of its publication date. Information, specifications, and prices are all subject to change without notice. Press-Seal is not responsible for any inadvertent errors. Copyright 2025.

